

Figure S1

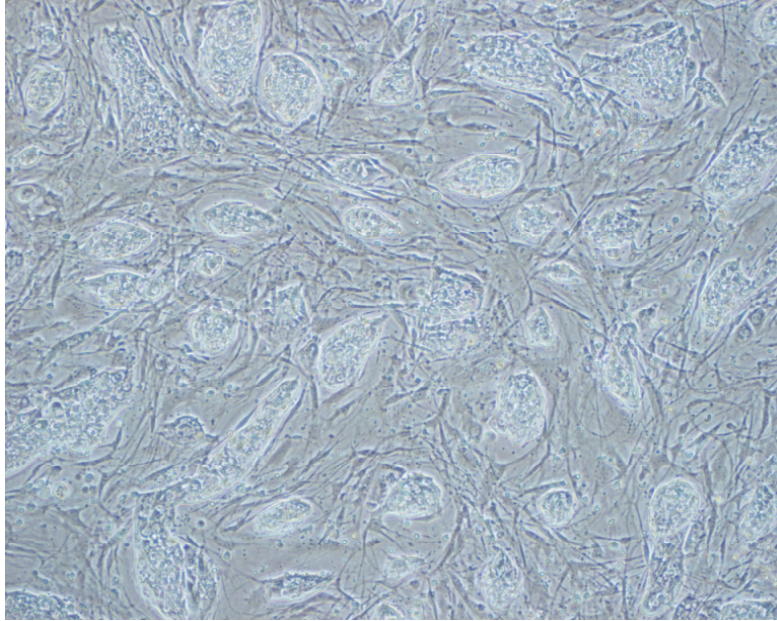

Figure S2

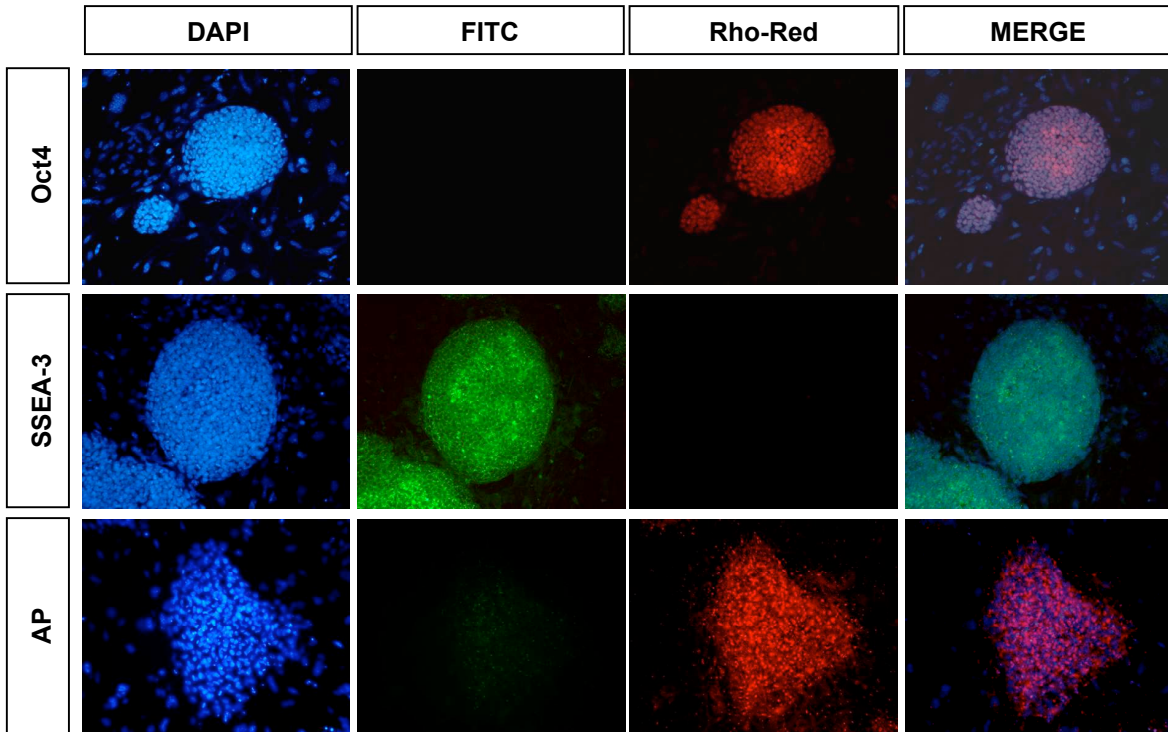

Figure S3

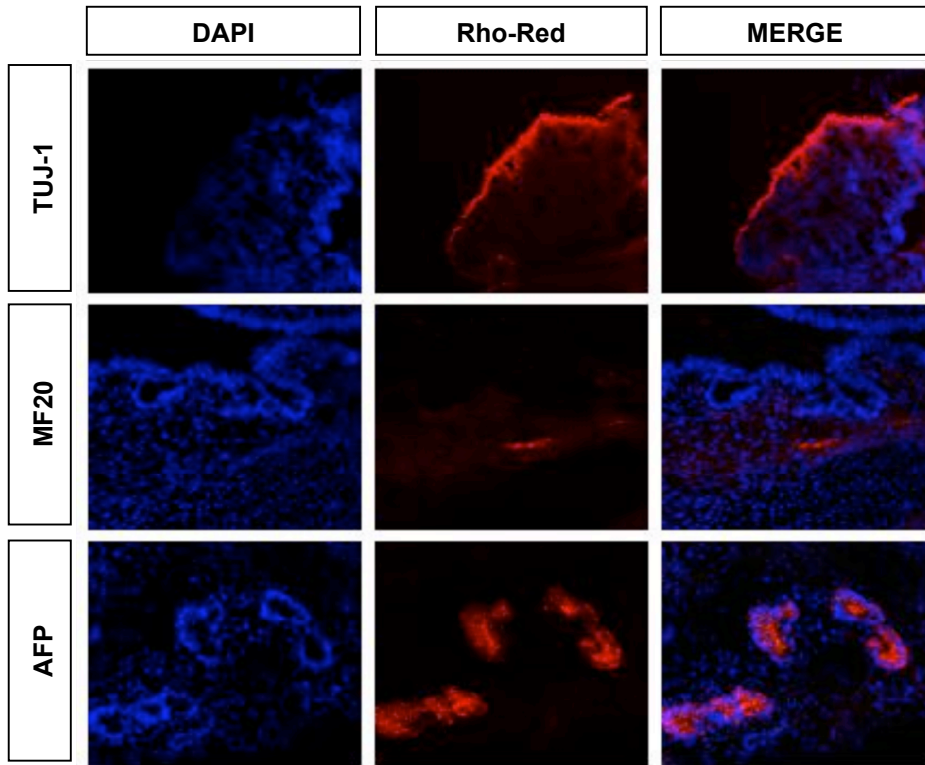

Figure S4

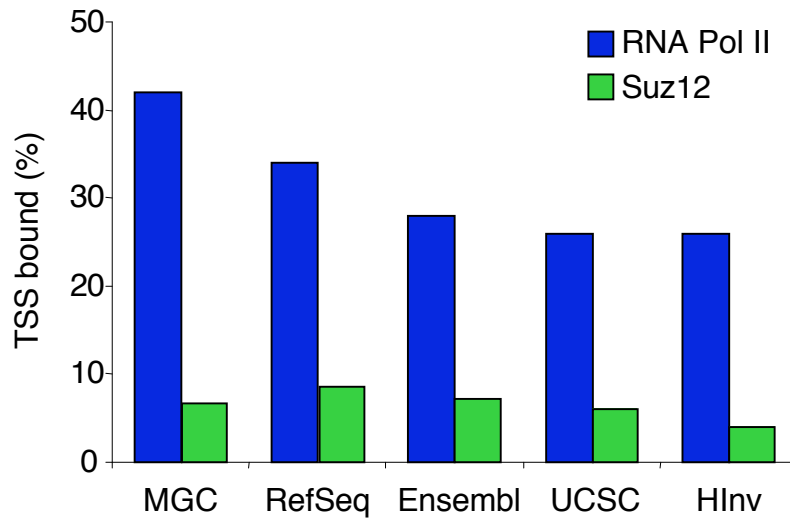

Figure S5

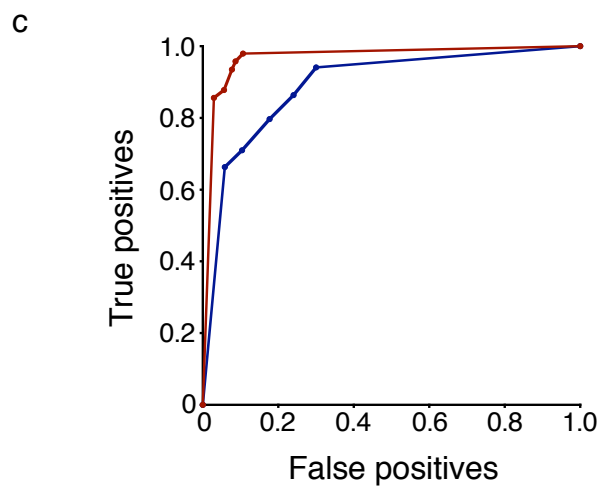
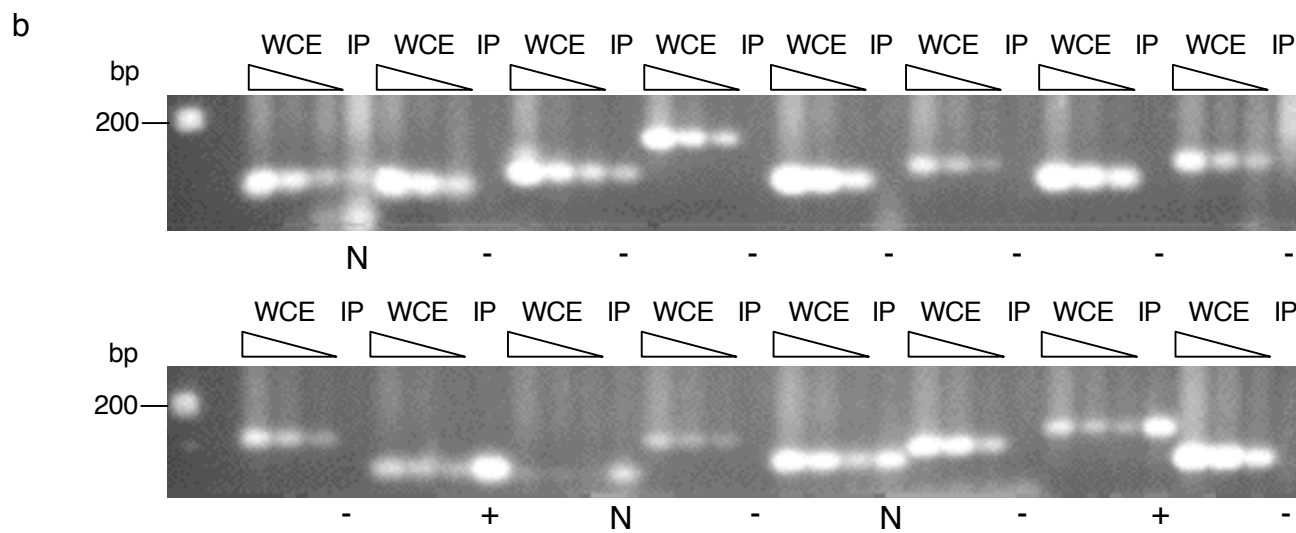
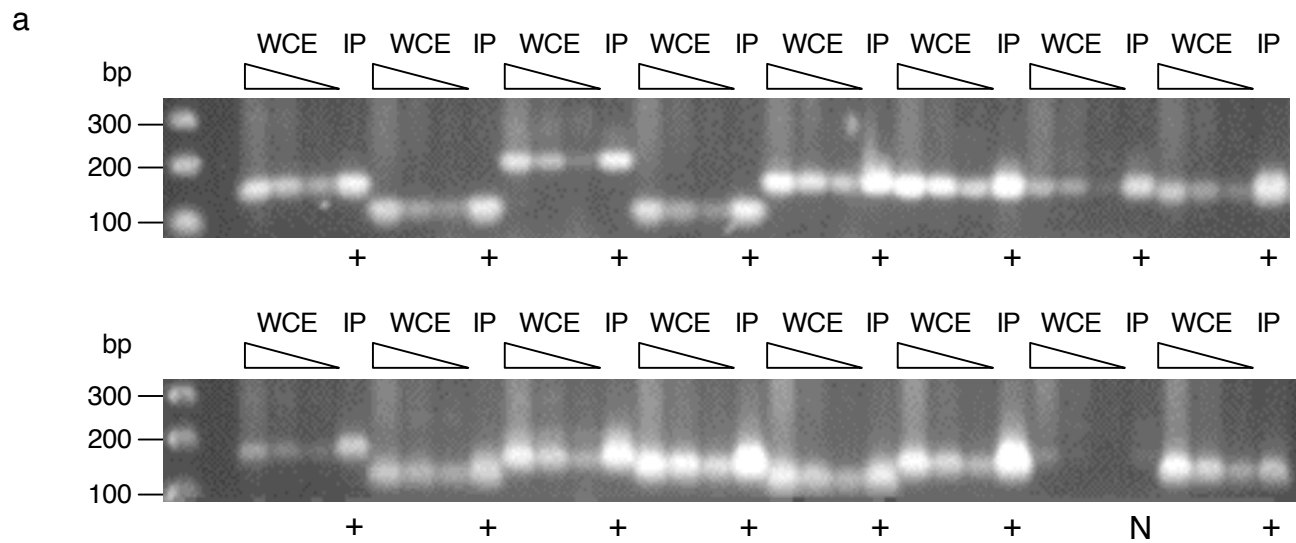

Figure S6

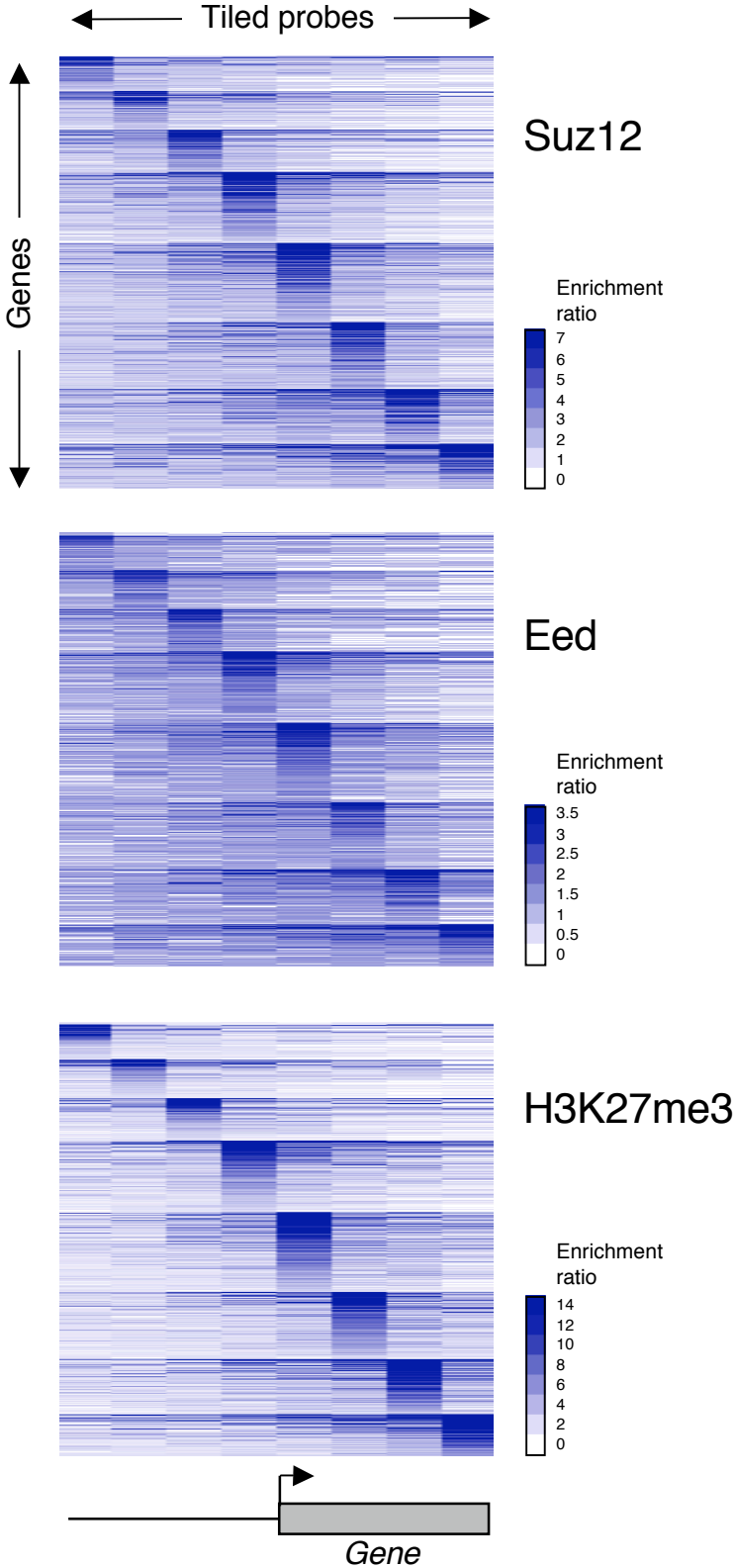

Figure S7

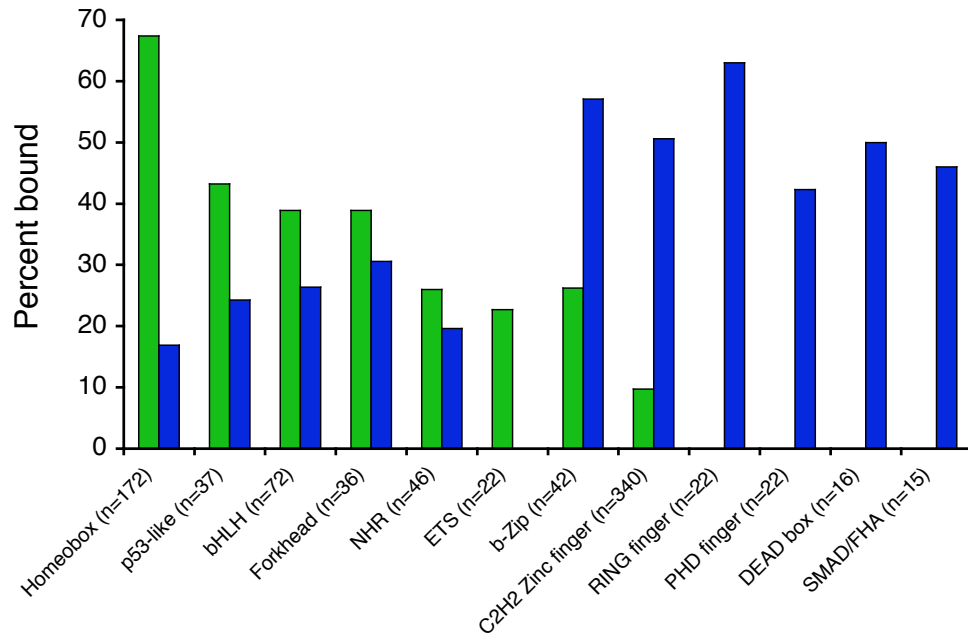

Figure S8

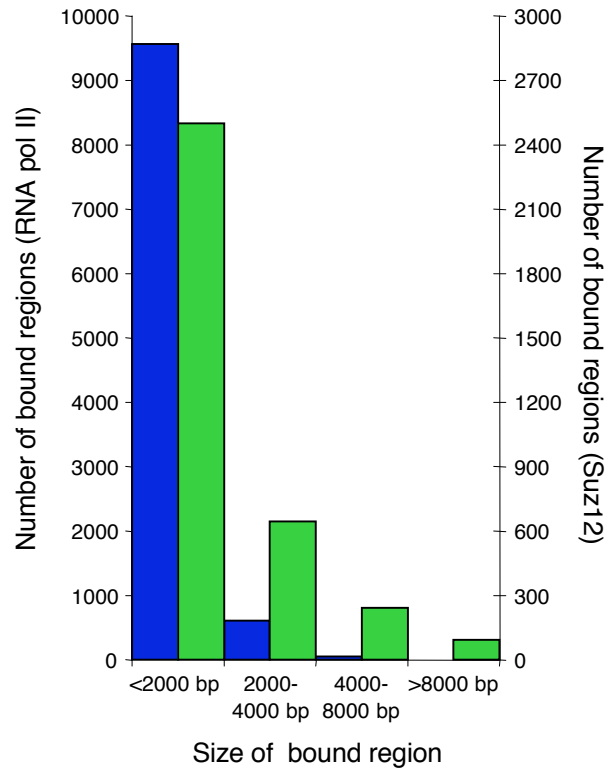
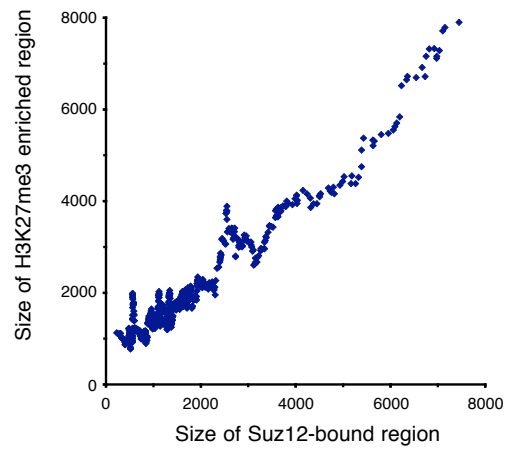



Figure S9

a



b

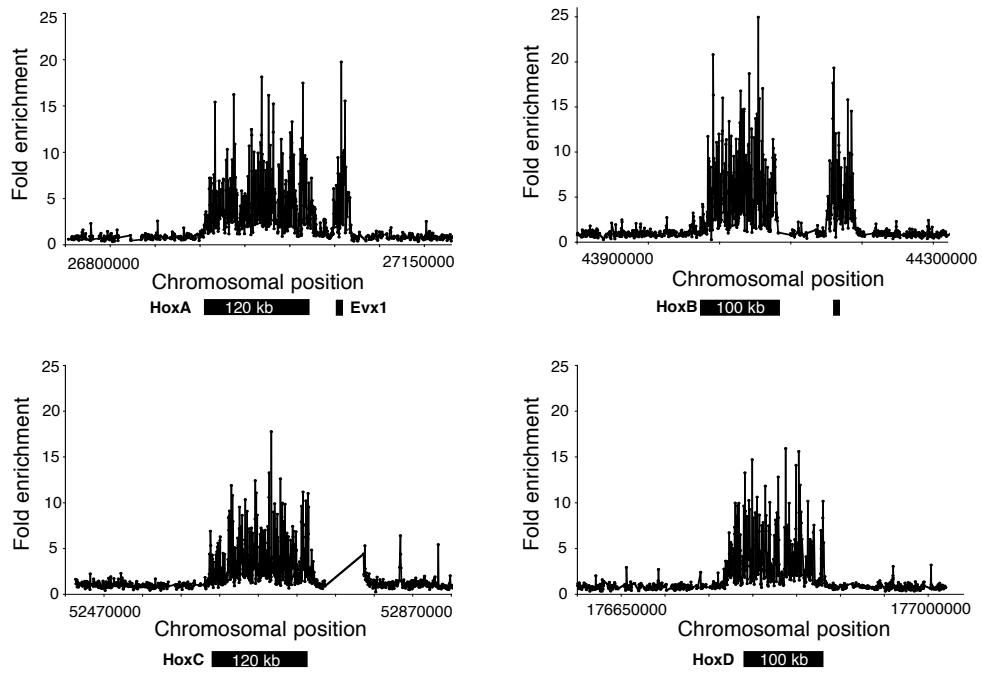

Figure S10

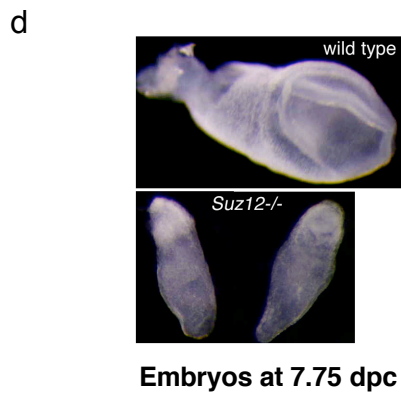
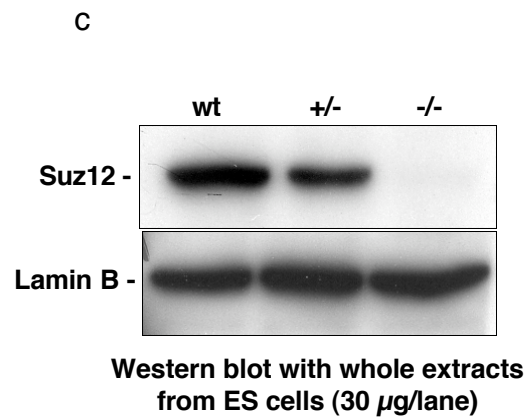
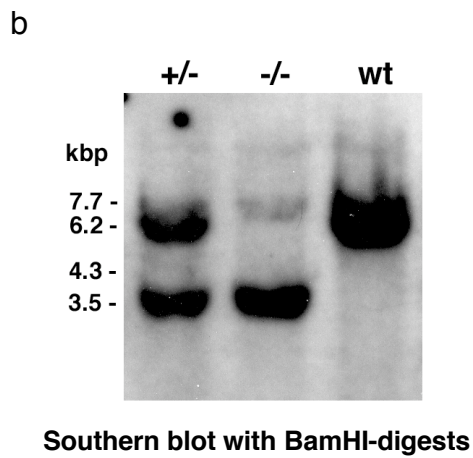
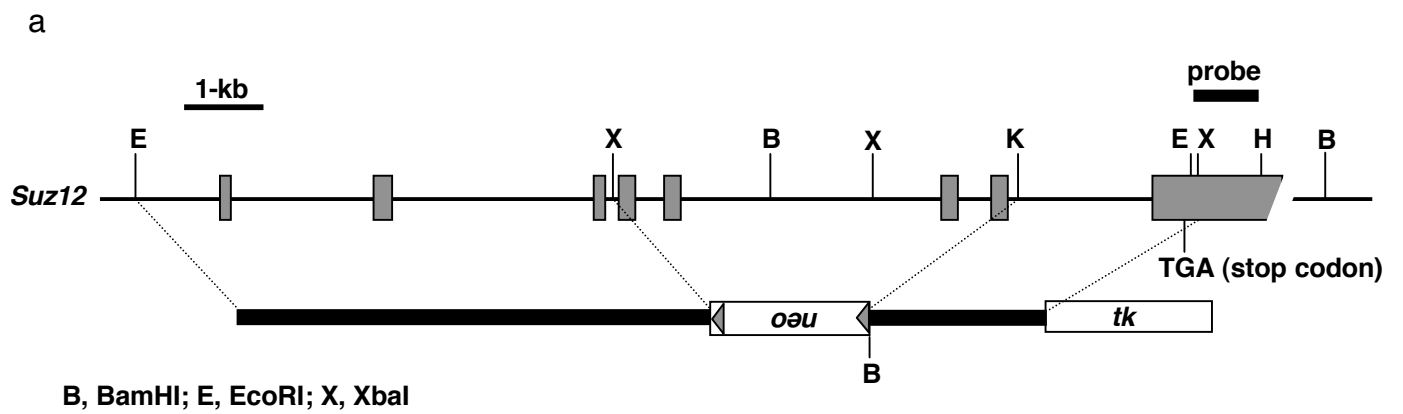

Figure S11

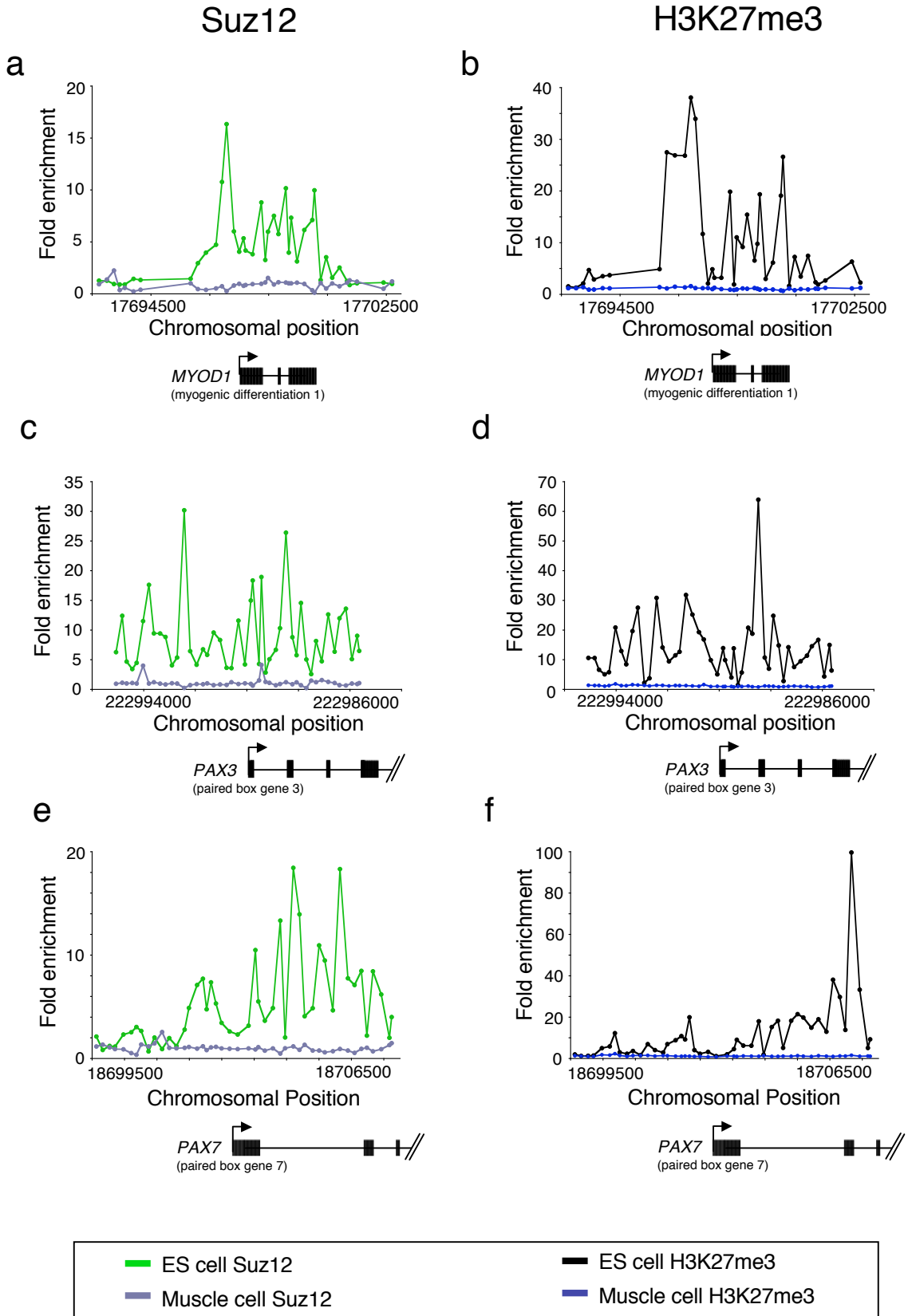

Figure S12

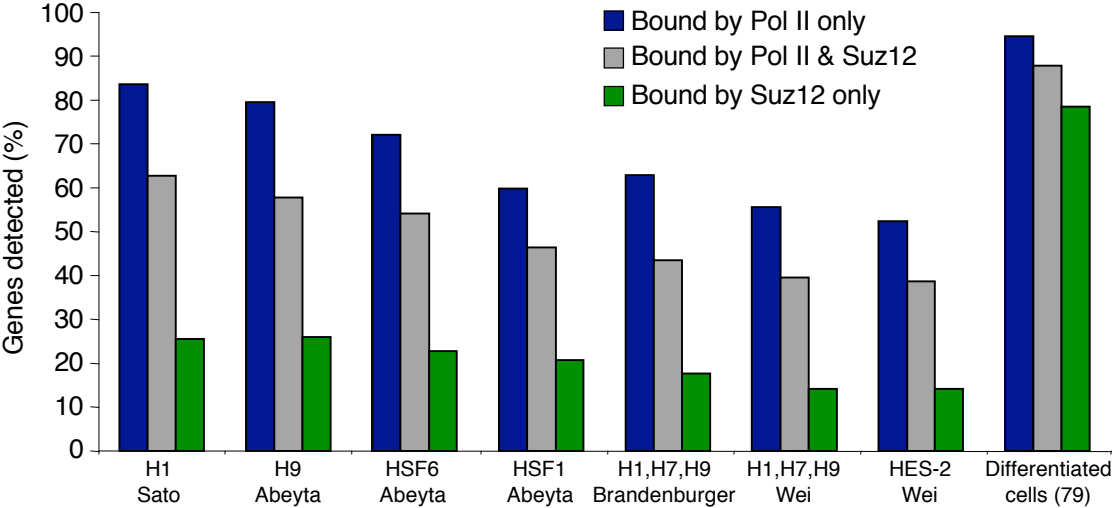

Figure S13

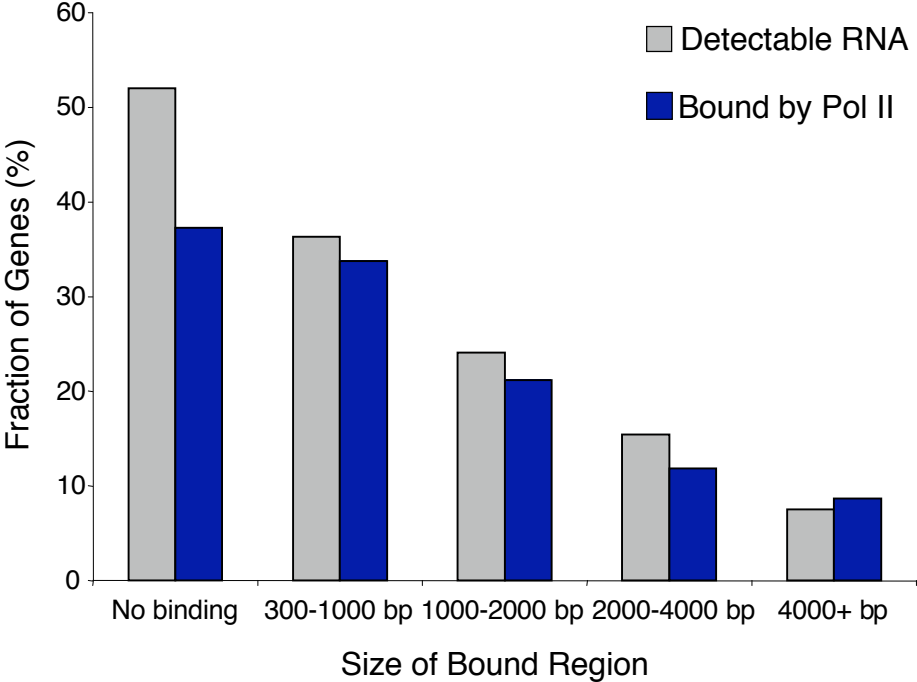
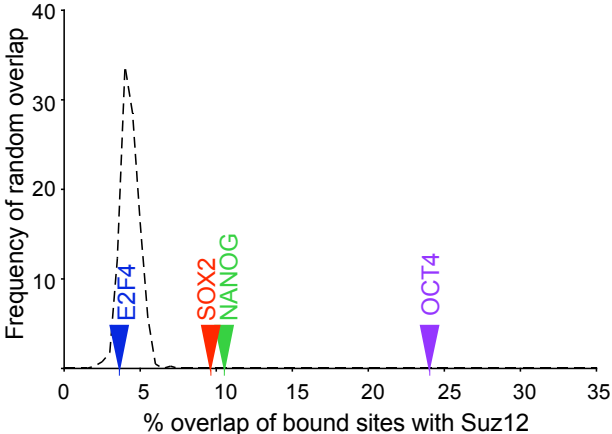

Figure S14

a



b

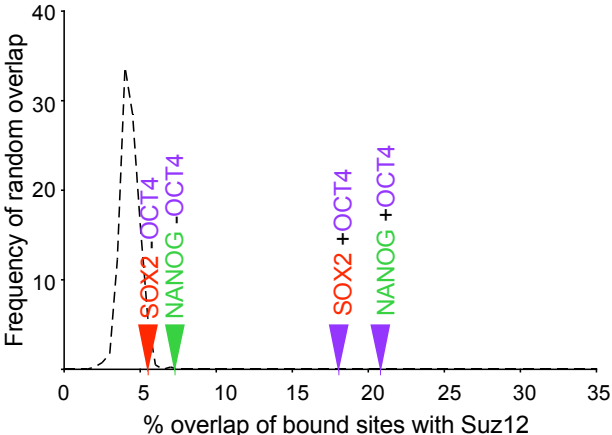
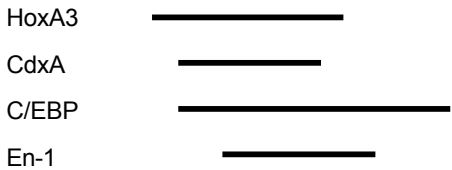

Figure S15

a



b



c

